



Wandverkleidungen

## METAL Wallcoustic Horizon 1000 / 1100

(METAL W-H 1000 / W-H 1100)

Gruppierte Elemente













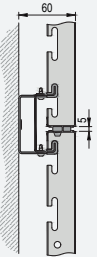
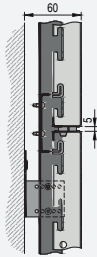



































- Bei den Lösungen **METAL Wallcoustic Horizon 1000** und **METAL Wallcoustic Horizon 1100** handelt es sich um Wandverkleidungssysteme, die in die zugehörige verdeckte System-Unterkonstruktion eingehängt werden.
- Platzsparendes System mit geringem Vorhängeabstand.
- Wandplatten können stehend oder liegend angeordnet werden.
- METAL Wallcoustic Horizon 1000 mit C-Wandprofil wird horizontal installiert, während METAL Wallcoustic Horizon 1100 mit U-Wandtragprofil vertikal installiert wird. Die Größe und Ausrichtung der Wandplatten sind ausschlaggebend für die Wahl des einen oder anderen Systems.
- Einfache Montage, Ausrichtung und Demontage.
- Eine komplette Verkleidung oder Abdeckung, zur Unterstützung der Raumakustik.
- Optional stehen im Rahmen unseres **Vario Design** Programms zusätzliche gestalterische Alternativen zur Verfügung.
- Akustische und architektonische Lösung welche Wände, Säulen und Stützen verkleidet, eingesetzt als Innenraumfassade, und vielfach verwendet im Bereich Büro, Bildung oder Transport.





# METAL Wallcoustic Horizon 1000 / 1100

Gruppierte Elemente

<b>Kantendetails</b>		<b>METAL Wallcoustic Horizon 1000</b> <small>vd</small> 	<b>METAL Wallcoustic Horizon 1100</b> <small>vd</small> 
<b>System</b>		C-Wandtragprofil	U-Wandtragprofil
<b>Abmessungen (mm)</b>		Plattenlänge: 600 - 3000 Plattenbreite: 250 - 1000 Maximalgröße (m <sup>2</sup> ): 3	Plattenlänge: 600 - 3000 Plattenbreite: 250 - 1000 Maximalgröße (m <sup>2</sup> ): 3
<b>Material &amp; Perforationen</b>		Beschichteter, verzinkter Stahl, 1.0mm	
		 Unperforiert  Standard-perforation <b>Rg 2516</b> <small>Ø: 2,5mm Freier Querschnitt: 16%</small>	 Mikro-perforation <b>Rd 1522</b> <small>Ø: 1,5mm Freier Querschnitt: 22%</small>
		<b>vd Sonstige Perforationen</b>  Rd 1511  Rg 1511  Rg 3013	
<b>Farben</b>		 RAL 9010	<b>vd Vario Design Farben</b>  Granit  Stahl  Grüner Marmor  Kupfer  Eiche  Messing  Sandstein  Beton  RAL 9003  RAL 9005  RAL 9006  RAL 9007  RAL 9016  Global White
			<b>vd Holzeffekte</b>  Esche  Bambus natur  Bambus karamell  Ahorn  Eiche  Amerikanische Kirsche  Amerikanische Walnuss
<b>Gewicht</b>		<b>Unperforiert</b> 8.6 - 11.3 kg/m <sup>2</sup>	<b>Rg 2516</b> 7.3 - 10.0 kg/m <sup>2</sup>
			<b>Rd 1522</b> 6.7 - 9.6 kg/m <sup>2</sup>
			<i>Das Gewicht variiert je nach Kantendetail und Akustikeinlage.</i>
<b>Licht-reflexion</b>		<b>Unperforiert</b> 85%	<b>Rg 2516</b> 70%
			<b>Rd 1522</b> 65%
			<i>Werte nur für RAL 9010 anwendbar.</i>
<b>Feuchtigkeits-beständigkeit</b>		<b>90% RH</b>	
<b>Reinigung</b>		  (nur Unperforiert)	 
<b>Nachhaltigkeit</b>		 EN ISO 14001 ≈14%	 EN ISO 14025 Silber*
			<i>*Werte nur für RAL 9010 anwendbar.</i>
<b>Gestaltungsmöglichkeiten</b>		 Farben	 Perforationen

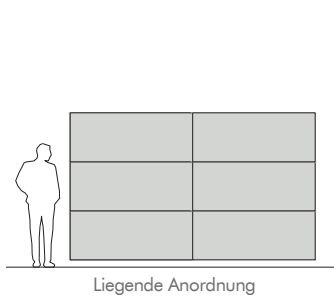
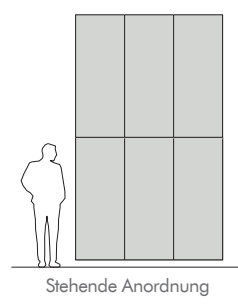
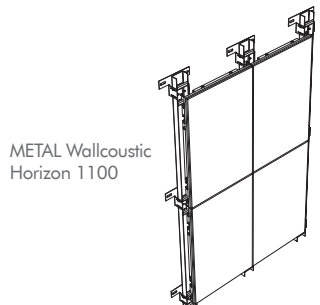
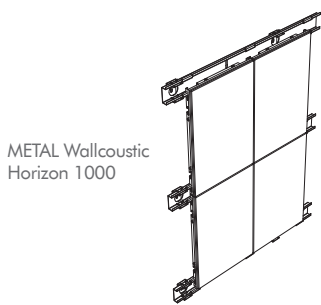

[vorherige Seite] METAL Wallcoustic Horizon 1100 (Internationaler Flughafen Dubai, Vereinigte Arabische Emirate, © Beppe Raso)

**vd** Produkte und Systeme mit diesem Symbol sind in unserem **Vario Design** Programm erhältlich. Einige Farbkombinationen und/oder Perforationen sind nicht für jedes Produkt erhältlich. Die Produktverfügbarkeit kann sich von Land zu Land unterscheiden. Für weitere Informationen wenden Sie sich bitte an Ihren persönlichen Vertriebsansprechpartner. Weitere Informationen und rechtliche Hinweise finden Sie auf unserer Website. [knaufceilingsolutions.com](http://knaufceilingsolutions.com)