



## ARMSTRONG METALWORKS™ R-H200 HOOK-ON SYSTEM

- METALWORKS™ R-H200 is the ultimate concealed grid ceiling system for a wide range of commercial applications.
- Visually elegant, sophisticated and yet simple.
- A versatile ceiling system with high design flexibility - available in standard or custom module sizes
- Directional hook-on panel with 3.0mm gasket
- Ease of installation (alignment) and fully demountable
- Easy access to the ceiling void
- Maintenance friendly system
- Wide range perforation patterns and colours

## Suspension and Accessories

Item Number	Description
<b>300100B</b>	U-Profile Channel (3750mm)
<b>300119</b>	U-Profile Channel Connector
<b>300266</b>	J-Bar for RH200 (3000mm)
<b>300307</b>	J-Bar Hanger
<b>300343</b>	J-Bar Connector
<b>UNITRCB</b>	Suspension Clip for M6 Threaded Rod
<b>300120B</b>	Plug-in Clip
<b>330056</b>	J-Bar Security Clip
<b>300140</b>	U-Profile Wall Anchor Bracket
<b>RA4F</b>	RA4F Aluminum Angle (25x25x3600mm)
<b>RA5F</b>	RA5F Aluminum Angle (20/20/20x25x3600mm)
<b>BP311081</b>	Pressure Spring (RA4F/RA5F)

Perimeter Option: Compatible standard range of steel or aluminum trim.

## Typical Schematic

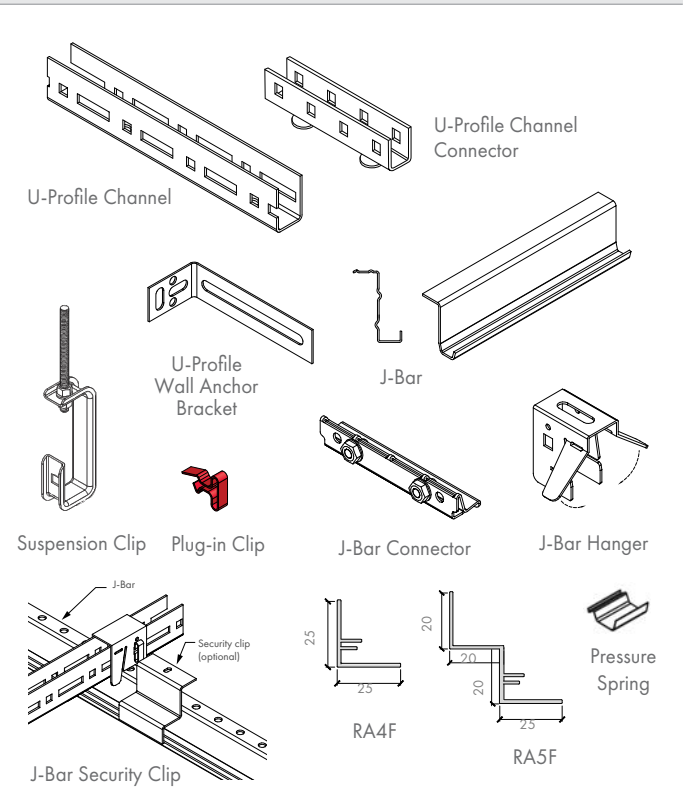



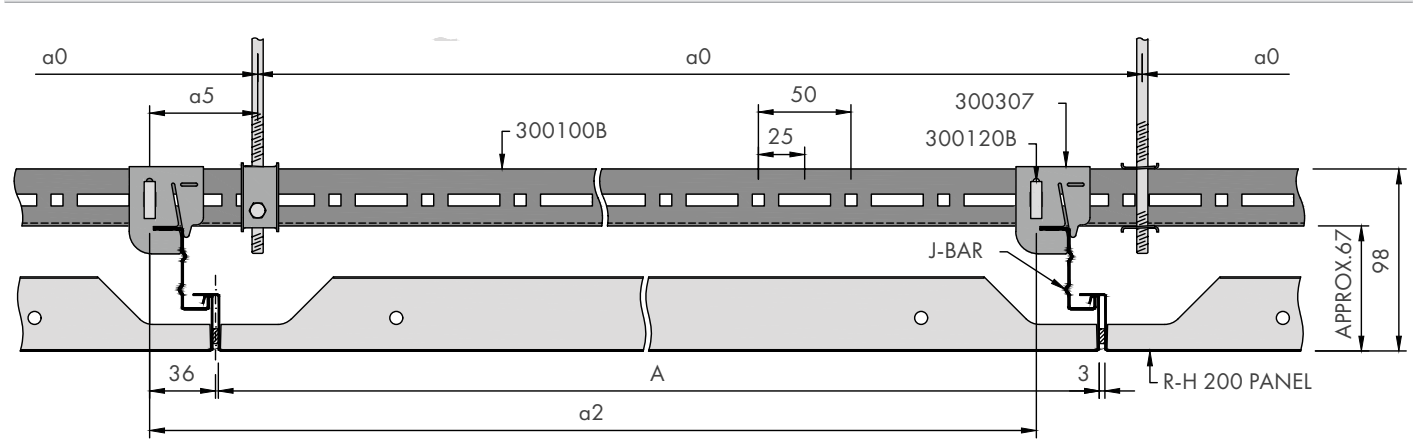



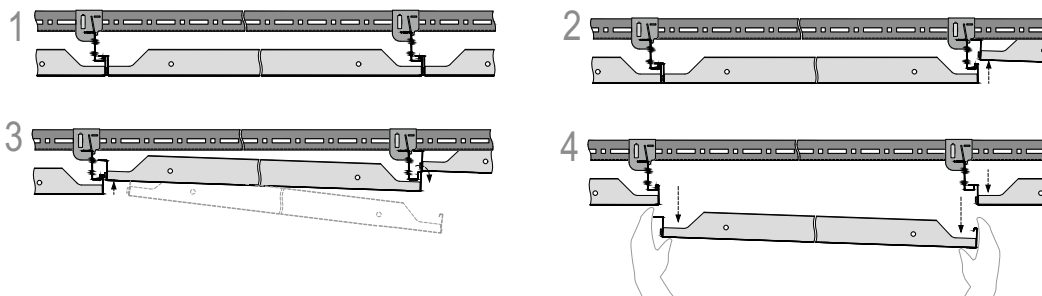



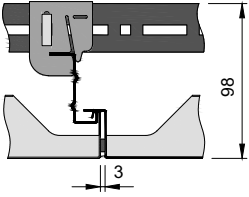
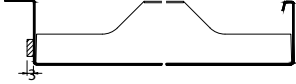



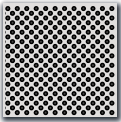
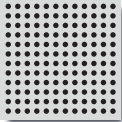
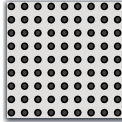



## Typical Section



### PANEL EXTRACTION



# ARMSTRONG METALWORKS™ R-H200 HOOK-ON SYSTEM

Panel Options	Metal R-H200 Hook-On Concealed Ceiling: Directional			
 <b>Edge details</b>	  <p>Square Edge, 3mm Gasket on one long and one short side (Optional without gasket)</p>			
 <b>Material</b>	Galvanized Steel (Aluminum optional)			
 <b>Patterns</b> * Perforated panels feature an unperforated border and include acoustical fleece.	 <p>Non Perforated (M1)</p>	 <p>Micro Perforated (M2) 1.5mm Ø 19% Open Area</p>	 <p>Micro Perforated (M9) 1.5mm Ø 9.5% Open Area</p>	 <p>Standard Perforated (M10) 2.5mm Ø 16% Open Area</p>
 <b>Dimensions (mm)</b>	400 x 1200 600 x 1200	Customizable Sizes: Panel length (mm): 600 – 3000 Panel width (mm): 247 – 1200 Max size (m <sup>2</sup> ): 2 (Additional Stiffeners might be applicable)		
 <b>Suspension System</b>	U Profile System with J-Profile			
 <b>Weight</b>	≈ 8.07 kg/m <sup>2</sup>			
 <b>Colour</b>	Polyester Powder Coated – Global White		 Wood Effects Available by Request	
 <b>Sound absorption</b>	NRC 0.70 (M2) / NRC 0.75 (M9) / NRC 0.80 (M10) - Perforated Option with fleece, without additional infill. Contact your local sales representative for test data.			
 <b>Sound attenuation</b>	Approximately 18 dB (without additional infill). <b>Optional:</b> High Attenuation Performance Up to 38dB (NRC 0.60) with additional mineral infill.			
 <b>Fire reaction</b>	CLASS 0/1 based on BS 476 Part 6 & 7			
 <b>Handling</b>	100% downward demountable without tooling. Optional Security clip available on request			
<b>Durability</b>				
<b>Cleanability</b>	  			

All sizes are nominal. Product availability may vary.

## Contact

For further details, please contact your local representative or email [asia.support@knaufarmstrong.com](mailto:asia.support@knaufarmstrong.com)