

ARMSTRONG METALWORKS™ R-H215 HOOK-ON SYSTEM

- METALWORKS™ R-H215 is the ultimate concealed grid ceiling system for a wide range of commercial applications.
- Visually elegant, sophisticated and yet simple.
- A versatile ceiling system with high design flexibility - available in standard or custom module sizes
- Non-Directional hook-on panel with 3.0mm gasket
- Ease of installation (alignment) and fully demountable
- Easy access to the ceiling void
- Maintenance friendly system
- Wide range perforation patterns and colours

Suspension and Accessories

Item Number	Description
300100B	U-Profile Channel (3750mm)
300119	U-Profile Channel Connector
311400	H-Bar for R-H215 (3000mm)
300307	J-Bar Hanger
BPHMC	H-Bar Connector
UNITRCB	Suspension Clip for M6 Threaded Rod
300120B	Plug-in Clip
300140	U-Profile Wall Anchor Bracket
RA4F	RA4F Aluminum Angle (25x25x3600mm)
RA5F	RA5F Aluminum Angle (20/20/20x25x3600mm)
BP311081	Pressure Spring (RA4F/RA5F)

Perimeter Option: Compatible standard range of steel or aluminum trim.

Typical Schematic

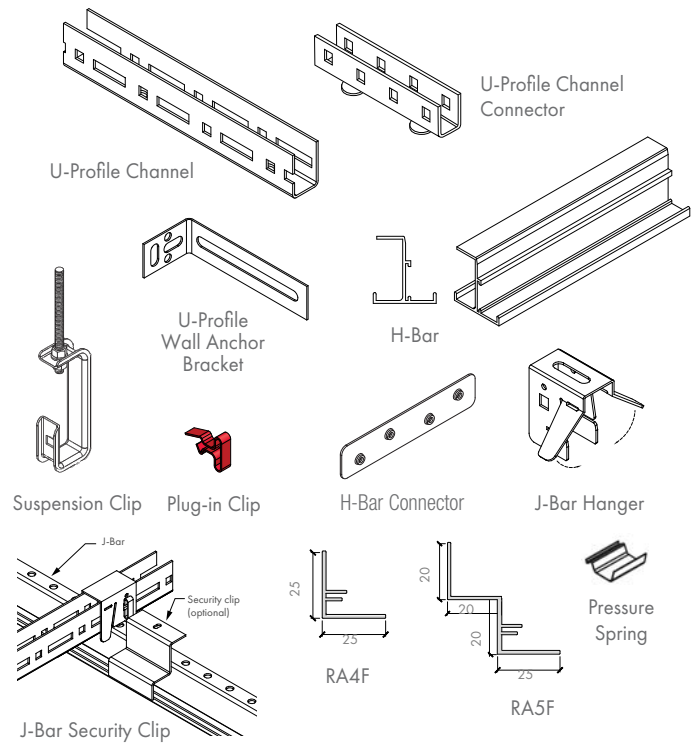



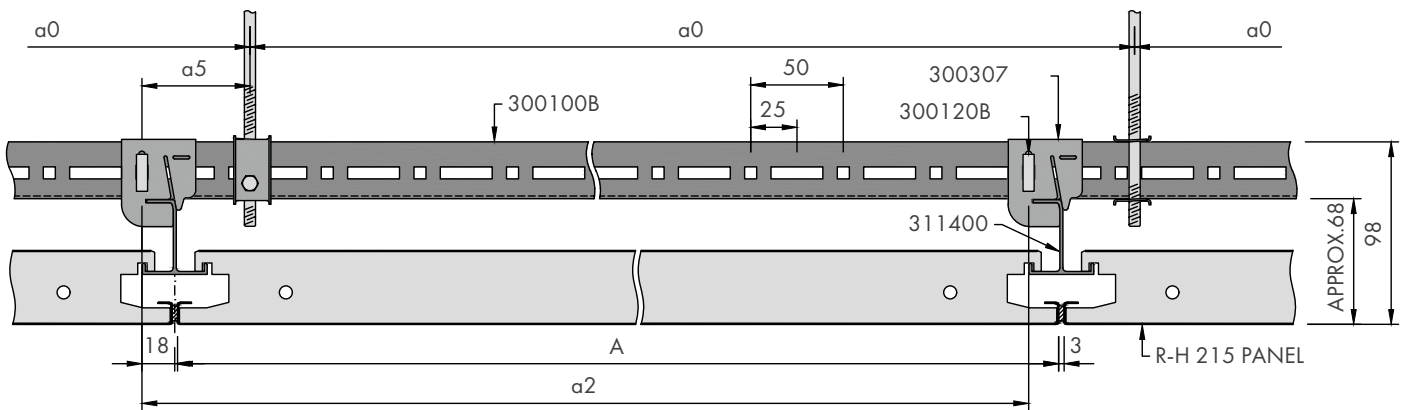



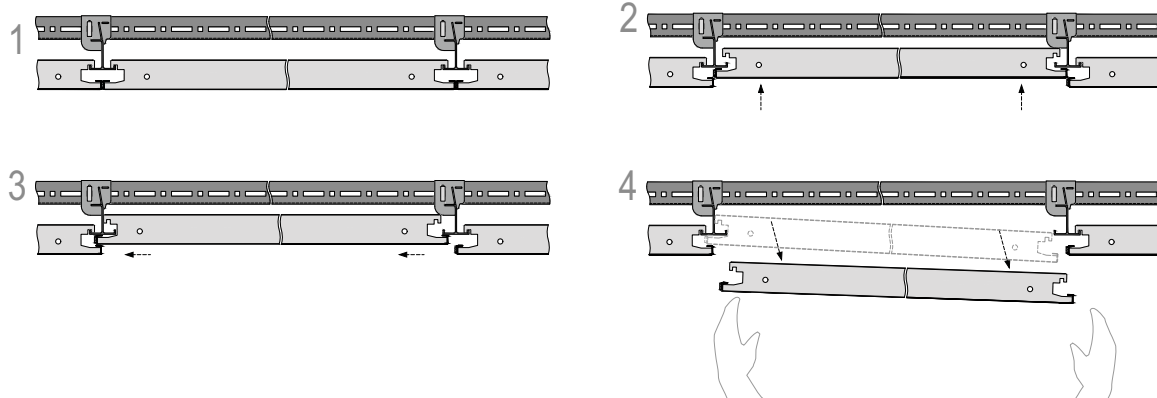



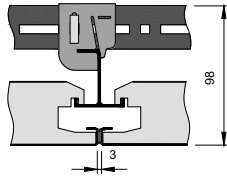
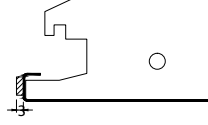



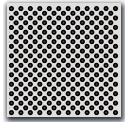
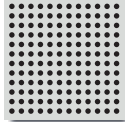
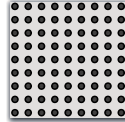



Typical Section



PANEL EXTRACTION



ARMSTRONG METALWORKS™ R-H215 HOOK-ON SYSTEM

Panel Options	Metal R-H215 Hook-On Concealed Ceiling: Non-Directional			
 Edge details	 		Square Edge, 3mm Gasket on one long and one short side (Optional without gasket)	
 Material	Galvanized Steel (Aluminum optional)			
 Patterns * Perforated panels feature an unperforated border and include acoustical fleece.	 <p>Non Perforated (M1)</p>	 <p>Micro Perforated (M2) 1.5mm Ø 19% Open Area</p>	 <p>Micro Perforated (M9) 1.5mm Ø 9.5% Open Area</p>	 <p>Standard Perforated (M10) 2.5mm Ø 16% Open Area</p>
 Dimensions (mm)	400 x 1200 600 x 1200	Customizable Sizes: Panel length (mm): 600 – 3000 Panel width (mm): 247 – 1200 Max size (m ²): 2 (Additional Stiffeners might be applicable)		
 Suspension System	U Profile System with H-Profile			
 Weight	≈ 8.07 kg/m ²			
 Colour	Polyester Powder Coated – Global White		 Wood Effects Available by Request	
 Sound absorption	Up to NRC 0.70 to 0.80 (Perforated Option with fleece, without additional infill) Contact your local sales representative for test data.			
 Sound attenuation	Approximately 18 dB (without additional infill). Optional: High Attenuation Performance Up to 38dB (NRC 0.60) with additional mineral infill.			
 Fire reaction	CLASS 0/1 based on BS 476 Part 6 & 7			
 Handling	100% downward demountable without tooling. Optional Security clip available on request			
Durability				
Cleanability	  			

All sizes are nominal. Product availability may vary.

Contact

For further details, please contact your local representative or email asia.support@knaufarmstrong.com